

TRP-C68

**8-Channel Analog Input to Digital Output Isolated Module
Support ASCII and Modbus RTU protocol**



USER'S MANUAL

Dec. 2010. Rev 1.2

Trycom Technology Co.,Ltd

1F, No.2-11,Sihu street ,Yingge Township, Taipei, Taiwan ROC

Tel: 886-2-86781191 , Fax: 886-2-86781172

Web: www.trycom.com.tw

Copyright

Copyright Notice: The information in this manual is subject to change without prior notice in order to improve reliability, design and function and does not represent a commitment on the part of the manufacturer. No part of this manual may be reproduced, copied, or transmitted in any form without the prior written permission of manufacturer. Acknowledgment Products mentioned in this manual are mentioned for identification purpose only. Products names appearing in this manual may or may not be registered trademarks or copyright of their respective companies.

1. Introduction

TRP-C68, an 8-channel Analog to Digital Converter (ADC), takes an analog input signal and converts the input into a digital output signal. It accepts analog input-a voltage or a current-and supports the sample rate in “Normal” or “Fast” mode. All channels feature screw terminals for convenient connection, All analog inputs are provided with isolation and surge protection to protect the module against high voltage spikes, as well as ground potential differences. TRP-C68 support both ASCII and Modbus protocol, with a full set of command, dual watch-dog, and auto reset function the module can be remote controlled by PC in ASCII or Modbus RTU protocol.

1-1. Features

- Support ASCII and Modbus RTU protocol.
- Photo Isolation 3750V between digital and analog.
- All channels can input analog signal by voltage or current.
- Baud rate from 1.2Kbps to 115.2Kbps.
- Surge protection on RS-485 interface.
- LED display to indicate power and communication.
- Dual Watchdog for hardware reset circuit and host operating status.
- External switch for hardware and module’s configuration.
- Support screw terminal, or external DC power supply.
- Wide input range DC power supply.

1-2. Specifications

- Resolution: 16 Bit
- Sample rate:
 - Normal mode: 10 sample / sec (24 bit).
 - Fast Mode: 60 sample / sec (16 bit).
- Bandwidth:
 - Normal Mode: 15.72Hz.
 - Fast Mode:/78.72Hz...fast.
- Zero drift: 0.03uV/C.
- Span drift: 25 ppm/C.
- Accuracy:
 - Normal 0.1 or better.
 - Fast: 0.5 or better.
- Analog Input range:
 - Voltage: $\pm 10V, \pm 5V, \pm 2.5V, \pm 1.25V, \pm 650mV$.
 - Current: $\pm 20 mA$
- CMRR:92db min/50/60Hz.
- Analog input over voltage protection: $\pm 35V$.
- RS485 connector: Industrial plug-in screw terminal.
- Communication Interface: RS485,2 wires.

- LED indicator: Power and communication.
- Transmission distance : 4000ft(1200M).
- Speed: From 1.2K to 115.2Kbps.
- Power consumption:1.2 Watt.
- Power requirement: DC input from +10 to 30 V.
- Operating Temperature: 0 to 60 .
- Storage Temperature: -20 to 60 .
- Humidity: 10-90%, Non-condensing.
- Dimension: 151mm X 75mm X 26mm.
- Weight: 398g.

1-3. Panel layout

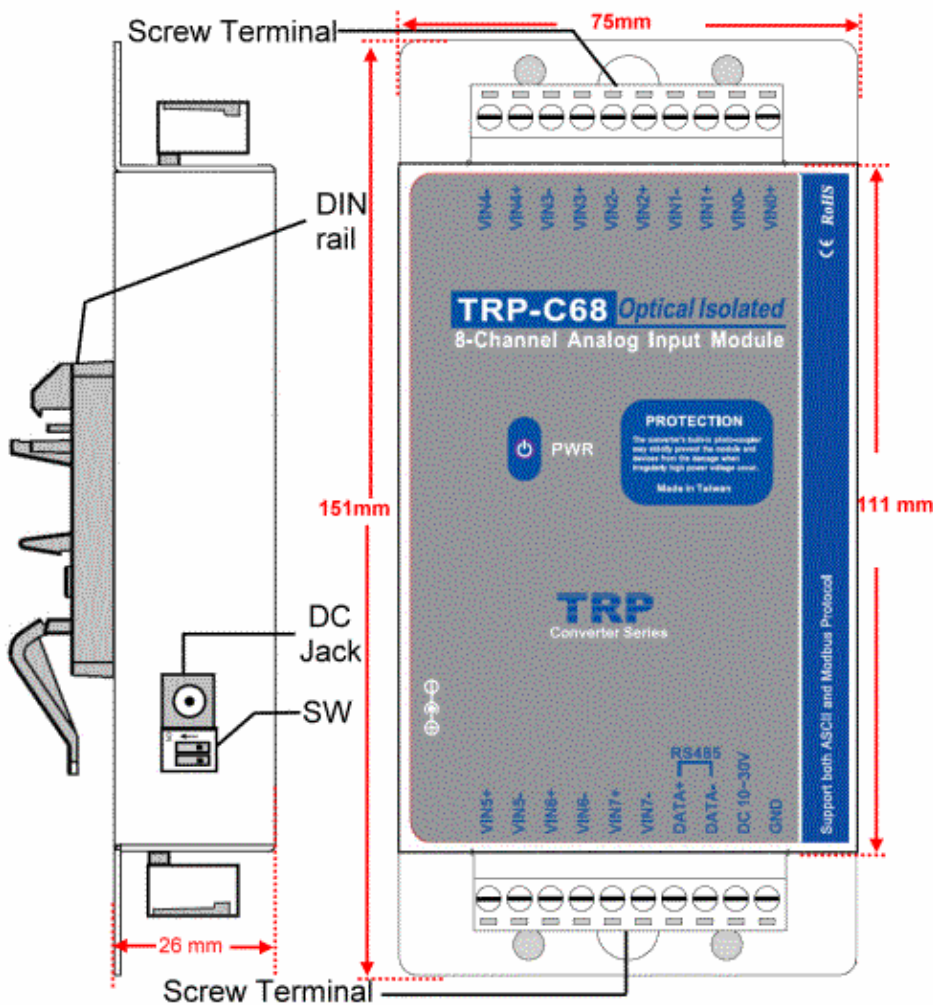

1-4. Block Diagram

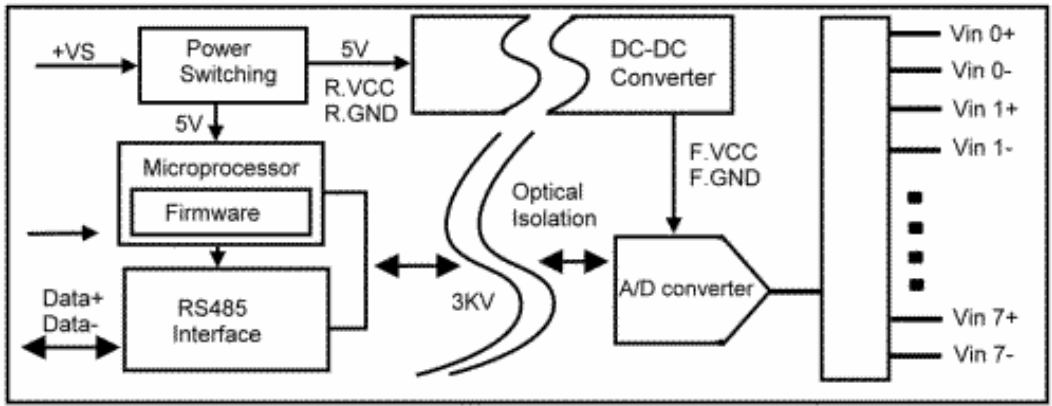

1-5. Pin Definitions

VIN5+	Analog Input Channel 5+	VIN4-	Analog Input Channel 4-
VIN5-	Analog Input Channel 5-	VIN4+	Analog Input Channel 4+
VIN6+	Analog Input Channel 6+	VIN3-	Analog Input Channel 3-
VIN6-	Analog Input Channel 6-	VIN3+	Analog Input Channel 3+
VIN7+	Analog Input Channel 7+	VIN2-	Analog Input Channel 2-
VIN7-	Analog Input Channel 7-	VIN2+	Analog Input Channel 2+
DATA+	RS485 DATA+	VIN1-	Analog Input Channel 1-
DATA-	RS485 DATA-	VIN1+	Analog Input Channel 1+
DC 10~30V	Input Voltage DC 10~30V	VIN0-	Analog Input Channel 0-
GND	Input Voltage Ground	VIN0+	Analog Input Channel 0+

1-6. Communication Wiring

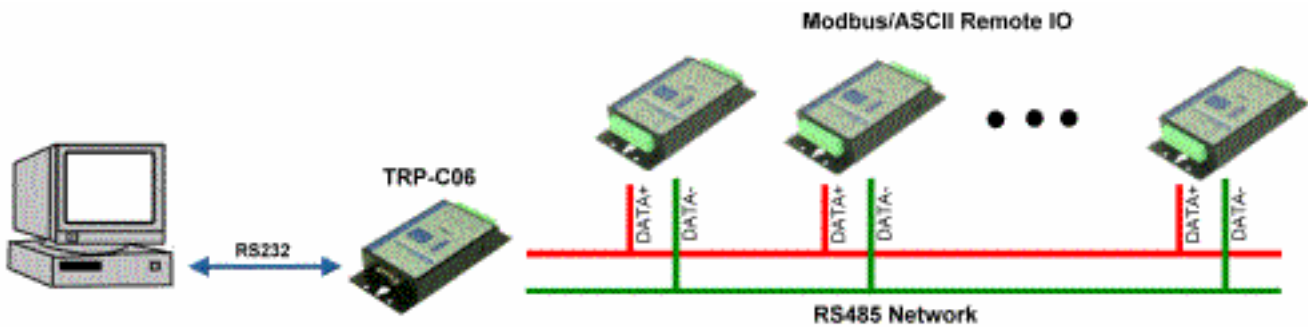

2. Wire Connection for Digital Input

2-1. Wire Connection For Current Input

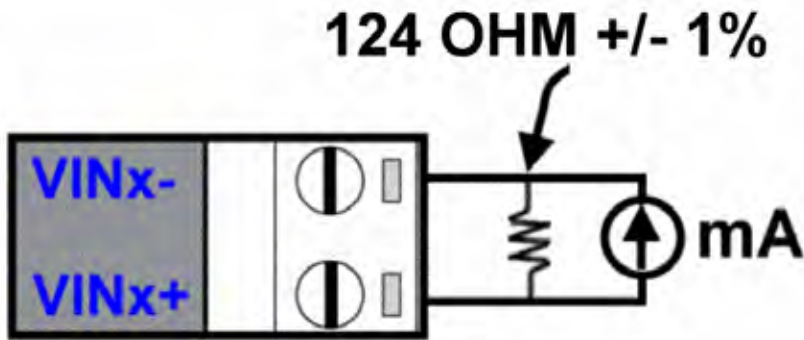

2-2. Wire Connection For Voltage Input

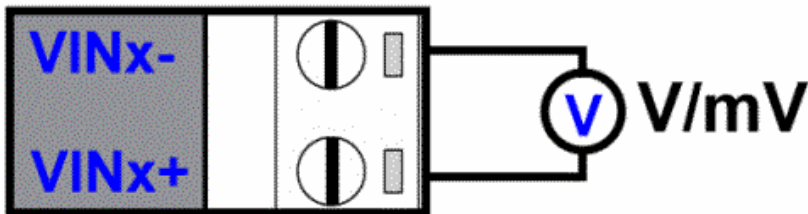

3. System Configuration Switch

The TRP-C68 DIO and AIO support the Modbus RTU and ASCII communication protocol, It has a two pins external dip-switch that allow user to select protocol between Modbus RTU and ASCII. The dip-switch also provides “back to INIT” function when user forget the configuring information stored in EEPROM such as ID (RS-485 Module address), baud rate and data format.

*TRP-C68 Default setting:

ID Address: 01,

Baud Rate: 9600,

Analog Mode Type: 08,

Checksum: Disable,

Data Format: 00,

All analog input channels: Enable,

RS485 communication data format: N, 8, 1.

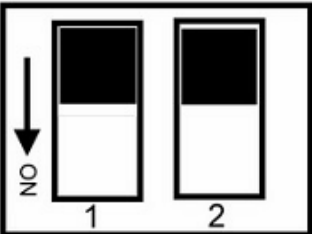
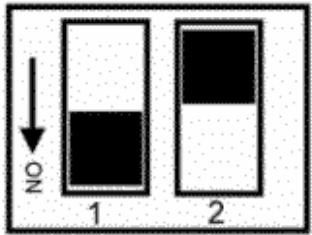
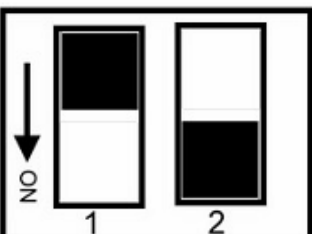
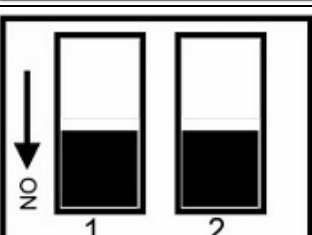
	<p>Modbus Protocol (Factory) Modbus Communication Protocol.</p>
	<p>Back to INIT for Modbus Step1. Adjust to “on off” position Step2. Reboot the system.</p>
	<p>ASCII Protocol ASCII communication protocol.</p>
	<p>Back to INIT for ASCII Step1. Adjust to “on on” position Step2. Reboot the system.</p>

*INIT: ID=00, Baud-Rate: 9600, Data format: 00, TT=08. RS485 communication protocol:N,8,1
 * The INIT* mode: if you forgot the C68 ID or baud-rate before you adjusted, you can adjust the switch to INIT* mode then easy to get ID=00.

4. Function description

Auto voltage calibration: The TRP-C68 will auto calibrate the voltage when power up. However user may also use voltage calibrating command to correct the voltage while the environment temperature is obvious difference, or the module was long period in idle. When the voltage must be calibrated by software command, it is necessary to reboot the module before calibration.

Dual Watchdog: Module self watchdog: The module's watchdog is a hardware reset circuit while working in harsh or noisy environment, the module may be down. The circuit may enable the module to continue working and never halt.

Host watchdog: The host watchdog is a software function to monitor the module's output states. The purpose is to prevent the RS-485 network from communication problem or host halt due to unexpected situation. When the timeout interval expired, the module will turn all outputs to predefined safe value. This can prevent the controlled target from unexpected situation.

5. ASCII Command Description

The TRP-C68 DIO and AIO support the ASCII communication protocol, the serial communication data format is Parity check: None, data Bit: 8, Stop bit: 1, baud rate can setting from 1200bps~115200bps.

5-1.Factory Setting

ID Address: 01,

RS485 communication protocol: 9600, 8, N, 1

AI Mode Type: $\pm 10V$

Checksum: Disable.

5-2.Protocol Syntax

Command Format:" Leading Code"+"ID Address"+"Command"+"CHK"+(cr) .

Response Format:"Leading Code"+"ID Address"+"Data"+"CHK"+ (cr) .

5-3. How to Calculate the Check Sum

1. Calculate the ASCII sum of all characters of the command string except the character return.
2. Mask the sum of string with OFFH.

Example:

Send the command is "\$06M".

Sum of string is "\$"+"0"+"6"+"M"="24H"+"30H"+" 4D"="A1H".....The checksum and [CHK]="A1".

Response string with checksum is : "A1".

5-4. ASCII Command List

Command List	Function Description	Page Index
%IDNNTTBDD(CHK)(cr)	Set the module configuration	5-5
#ID(CHK)(cr)	Read all analog input	5-9
#IDN(CHK)(cr)	Read analog input from N channel	5-10
\$ID2(CHK)(cr)	Read the module's configuration	5-11
\$ID5(CHK)(cr)	Read reset status	5-12
\$ID6HL(CHK)(cr)	Select analog input channel enable/disable	5-13
\$ID7(CHK)(cr)	Read analog channel enable/disable status	5-14
~01EV(CHK)(cr)	Set up the calibration enable/disable	5-15
\$ID8(CHK)(cr)	Perform zero calibration	5-16
\$ID9(CHK)(cr)	Perform full calibration	5-17
\$IDRS(CHK)(cr)	Perform software reset	5-18
\$IDM(CHK)(cr)	Read the module's name	5-19
\$IDF(CHK)(cr)	Read the module's firmware version and date	5-20
~IDONN(CHK)(cr)	Change the module's name	5-21
~IDWENN(CHK)(cr)	Enable watch dog and set up timeout value	5-22
~IDWD(CHK)(cr)	Disable watchdog	5-23
~IDWR(CHK)(cr)	Read watchdog timeout value	5-24
~**(CHK)(cr)	System stand by (Host ok!)	5-25

5-5. Set the module's configuration

**The module must be reboot, When you set up module's configuration after.*

Command	%IDNNTTBBDD(CHK)(cr)	
Syntax	%	First leading code
	ID	Address of setting module from 00~FF(HEX)
Description	NN	New address of setting from 00~FF(HEX)
	TT	Analog input type setting
	BB	New baud rate setting
	DD	Data Format
	CHK	Checksum
	(cr)	Carriage return
	Response	!ID(CHK)(cr)
?ID(CHK)(cr)		Command Invalid

5-6. (TT) Analog input type

Type Code	08	09	0A	0B	0C	0D	
Voltage:	±10V	±5V	±2.5V	±1.25V	±650mV	±20mA	
% of FSR	±100 %	±100 %	±100 %	±100 %	±100 %	±100 %	
2'S complement	Fast Mode	0000~8000~FFFF	0000~8000~FFFF	0000~8000~FFFF	0000~8000~FFFF	0000~8000~FFFF	0000~8000~FFFF
	Normal Mode	000000~800000~FFFFFF	000000~800000~FFFFFF	000000~800000~FFFFFF	000000~800000~FFFFFF	000000~800000~FFFFFF	000000~800000~FFFFFF

5-7. (BB) Baud Rate Setting

Code number	03	04	05	06	07	08	09	0A
Baud rate	1200	2400	4800	9600	19200	38400	57600	115200

5-8. (DD) Data format setting

Bit	7	6	5	4	3	2	1	0
Function	Rejection *0=60Hz 1=50Hz	Checksum *0:Disable 1:Enable	Mode *0=Normal 1=Fast	0	0	0	Engineer Unit Format *00=Voltage 01=Percent 10=2's Complement HEX Format	

Example:

Send command:"%0003080600",

New ID=03, Analog input= ±10V, Baud Rate=9600, Checksum=Disable DD=00

, Response:"!03".

***If you turn on the system setting switch, the ID will become to "00",**

Then send command read analog input CH-0 voltage "#030",

Response:" >03+07.63178" =+7.63178V / Unit: Voltage.

Example: Send command:%00030B0501 Response:"!03,

New ID=03, Analog input= ±1.25V, Baud Rate=4800, Checksum=Disable DD=01.

Then send command read analog input CH-0 FSR of percent "#030",

Response:" >03+063.3626" =63.3626 % / Unit: %.

Example: Send command:%0101080602 Response:"!01,

New ID=01, Analog input= ±10V, Baud Rate=9600, Checksum=Disable,

Normal mode, DD=02.

Then send command read analog input CH-0 FSR of percent "#010",

Response:" >01**7FF99F** / Unit: 2's complement 3 Byte

000000~800000~FFFFFF.

***TRPCOM utility is the utility for user to configure the module, the utility also with on-line RS485 modules scanning and searching function. You can find the utility in the TRP-C68 support CD which is bundled in TRP-C68 standard package.**

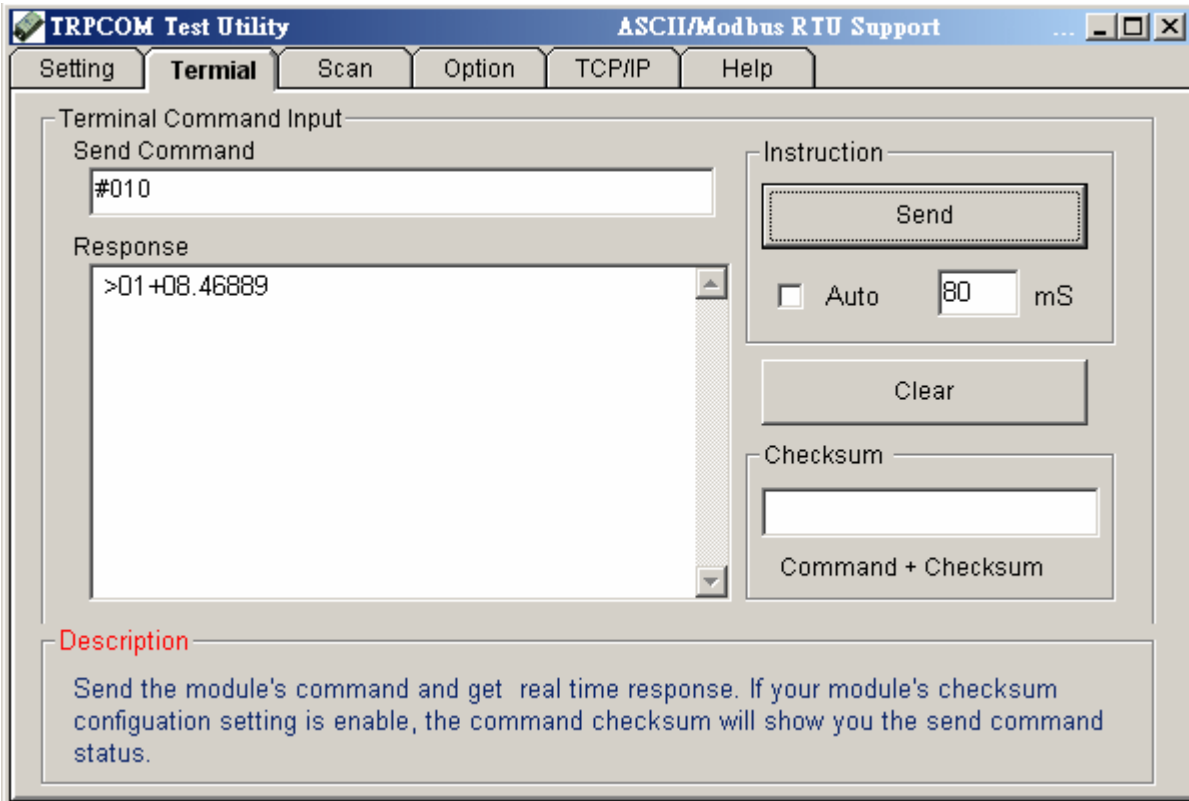

5-9. Read all analog input

Command	#ID(CHK)(cr)	
Syntax Description	#	First leading code
	ID	Address of setting module from 00~FF(HEX)
	CHK	Checksum
	(cr)	Carriage return
Response	!IDData0~7(CHK)(cr)	Channel 0,1,2,3,4,5,6,7 Data
	?ID(CHK)(cr)	Command Invalid

Example

Send command:"#01" Read the all analog input channels data.

IF TT=08 the data will be show

Response: ">01+02.667+00.006+00.002+00.000+00.000+00.000+00.000+00.000".....Show the channel 0~7 voltage between -10V~+10V. / Unit: Voltage

5-10. Read analog input from N channel

Command	#IDN(CHK)(cr)	
Syntax	#	First leading code
	ID	Address of setting module from 00~FF(HEX)
Description	N	Analog channel 0~7
	CHK	Checksum
	(cr)	Carriage return
Response	!IDData(CHK)(cr)	Data: Channel N data
	?ID(CHK)(cr)	Command Invalid

Example:

Send command:"#010" Read the analog input channel 0 value.

Response: >01+03.82062 Channel 0=+3.82062. /Unit: Voltage

5-11. Read Module's Configuration

Command	\$ID2(CHK)(cr)	
Syntax	\$	First leading code
	ID	Address of setting module from 00~FF(HEX)
Description	2	Read module's configuration
	CHK	Checksum
	(cr)	Carriage return
Response	!IDTTBD00(CHK)(cr)	TT: Analog input type BD: Baud rate type
	?ID(CHK)(cr)	Command Invalid

Example:

Send command:"\$012"Read module's configuration.

Response:!01**080600** TT=08=-10V~+10V..... Refer 5-6
, Baud rate=06=9600.....Refer 5-7.

5-12. Read reset status

Command	\$ID5(CHK)(cr)	
Syntax	\$	First leading code
	ID	Address of setting module from 00~FF(HEX)
Description	5	Read reset status
	CHK	Checksum
	(cr)	Carriage return
	!IDS(CHK)(cr)	S =1 Reset S =0 No Reset
Response	?ID(CHK)(cr)	Command Invalid

Example:

Send command: "\$015".

Response: !011 1:Module have been reset.

*If the module is system halt or detect abnormal voltage, the module will auto restart and flag of reset set up to "1" until use "\$ID5".

5-13. Select analog input channel enable/disable

Command	\$ID6HL(CHK)(cr)	
Syntax	\$	First leading code
	ID	Address of setting module from 00~FF(HEX)
Description	6	Set up channel enable/disable
	HL	H: Channel 4~7, L: Channel 0~3 , 0:disable 1:enable
	CHK	Checksum
	(cr)	Carriage return
	!ID(CHK)(cr)	Command valid
Response	?ID(CHK)(cr)	Command Invalid

Example:

Send command:"\$0160F"Channel0~3 enable, Channel4~7 disable,

Response: !01.

Then send command:"#01".....Read channel 0~7,
 Response:" +02.130+07.512-01.765-02.986+00.000+00.000+00.000+00.000,
 From channel 4~7 is disable.

5-14. Read analog input channel enable/disable status

Command	\$ID7(CHK)(cr)	
Syntax	\$	First leading code
	ID	Address of setting module from 00~FF(HEX)
Description	7	Read analog input channel enable/disable status
	CHK	Checksum
	(cr)	Carriage return
Response	!DHL(CHK)(cr)	H: Channel 4~7 L: Channel 0~3 0:Channel disable 1:Channel Enable
	?ID(CHK)(cr)	Command Invalid

Example:

Send command:"\$017",
 Response: "!010F" Channel 4~7 disable, Channel 0~3 enable.

5-15. Set up the calibration Enable/Disable

Command	~IDEV(CHK)(cr)	
Syntax	\$	First leading code
	ID	Address of setting module from 00~FF(HEX)
Description	EV	V=0 Disable V=1 Enable
	CHK	Checksum
	(cr)	Carriage return
Response	!ID(CHK)(cr)	Command valid
	?ID(CHK)(cr)	Return not enable calibration before calibration command

Example:

Send command:"~01E1",
 Response: "!01"..... Enable calibration.

****Refer to paragraph 4 Function description before calibration.***

5-16. Perform Zero Calibration

Command	\$ID8(CHK)(cr)	
Syntax	\$	First leading code
	ID	Address of setting module from 00~FF(HEX)
Description	8	Perform zero calibration
	CHK	Checksum
	(cr)	Carriage return
Response	!ID(CHK)(cr)	Command valid
	?ID(CHK)(cr)	Return not enable calibration before calibration command

Example:

Send command: "\$018",

Response: "!01".

****Refer to paragraph 4 Function description before calibration.***

5-17. Perform Full Calibration

Command	\$ID9(CHK)(cr)	
Syntax	\$	First leading code
	ID	Address of setting module from 00~FF(HEX)
Description	9	Perform full calibration
	CHK	Checksum
	(cr)	Carriage return
Response	!ID(CHK)(cr)	Command valid
	?ID(CHK)(cr)	Return not enable calibration before calibration command

Example:

Send command: "\$019",

Response: "!01".

****Refer to paragraph 4 Function description before calibration.***

5-18. Perform software Reset

Command	\$IDRS(CHK)(cr)	
Syntax description	\$	First leading code
	ID	Address of setting module 00~FF(HEX)
	RS	Reset the module
	CHK	Check sum
	(cr)	Carriage return
Response	!ID(CHK)(cr)	Command valid
	?ID(CHK)(cr)	Command Invalid

Example:

Send command:"\$01RS".....Reset ,

Response:"!01".....Have been reset.

5-19. Read the module's name

Command	\$IDM(CHK)(cr)	
Syntax description	\$	First leading code
	ID	Address of setting module 00~FF(HEX)
	M	Reading module's name
	CHK	Check sum
	(cr)	Carriage return
Response	!IDNNNNNN(CHK)(cr)	NNNNNN :The chars from 1 -6 chars
	?ID(CHK)(cr)	Command Invalid

Example:

Send command:\$01M...Read the TRP-C68's name ,

Response:"!01TRPC68"..... The module's name is "TRPC68."

5-20. Read the module's firmware version

Command	\$IDF(CHK)(cr)	
Syntax Description	\$	First leading code
	ID	Address of setting module from 00~FF(HEX)
	F	Read firmware
	CHK	Checksum
	(cr)	Carriage return
Response	!IDNNYYMMDD(CHK)(cr)	NN: Module's name YYMMDD: Release Date
	?ID(CHK)(cr)	Command Invalid

Example:

Send command:\$01F...Read the module's firmware version,

Response:" !01C68M070407"..... The module's version date is "07/04/2007".

5-21. Change the module's name

Command	~IDONN(CHK)(cr)	
Syntax description	~	First leading code
	ID	Address of setting module 00~FF(HEX)
	O	Command for rename module
	NN	NN: TRP-C24's name, Max.6 characters
	CHK	Checksum
	(cr)	Carriage return
Response	!ID(CHK)(cr)	Command valid
	?ID(CHK)(cr)	Command Invalid

Example:

Send command:"~01Oabcdef"..... Change the module name become to "abcdef",

Response:"!01"..... . Command valid.

Then send the command "\$01M"...read the module name,

Response:"!01abcdef"..... .The TRP-C68's name is "abcdef".

5-22. Enable watchdog and set the timeout value

Command	~IDWENN(CHK)(cr)	
Syntax description	~	First leading code
	ID	Address of setting module 00~FF(HEX)
	WE	Watchdog Enable
	NN	Set the watchdog time(NN:00~FF) One Unit=0.1 Sec FF: MAX. 25.5 Sec
	(cr)	Carriage return
Response	!ID(CHK)(cr)	Command valid
	?ID(CHK)(cr)	Command Invalid

Example:

Send Command:"~01WEFF"..... Set the watchdog time for 25.5 Sec,

Response:"!01"..... . Command valid, When module count to 25.5 Sec the watchdog will into safe mode, then PWR LED will flash, if the host send "~**" before timeout, the watchdog will recount.

5-23. Disable watchdog

Command	~IDWD(CHK)(cr)	
Syntax description	~	First leading code
	ID	Address of setting module 00~FF(HEX)
	WD	Disable watchdog
	(cr)	Carriage return
	Response	!ID(CHK)(cr)
	?ID(CHK)(cr)	Command Invalid

Example:

Send Command:"~01WD"..... Watchdog disable.

Response:"!01"..... . Command valid, System LED will stop flashing.

5-24. Read watchdog timeout value

Command	~IDWR(CHK)(cr)	
Syntax description	~	First leading code
	ID	Address of setting module 00~FF(HEX)
	WR	Read watchdog timeout value
	CHK	Check sum
	(cr)	Carriage return
Response	!IDWANN (CHK)(cr) !ID (CHK)(cr)	W: watchdog A=E: watchdog enable D: watchdog disable or safe mode NN: watchdog timeout value
	?ID(CHK)(cr)	Command Invalid

Example:

Send Command:"~01WR".... Read watchdog timeout value,

Response:" !01WD0F"..... . Command valid, set the watchdog timeout is "0F"..1.6 Sec.

5-25. System stand by (Host OK!)

Command	~**(CHK)(cr)	
Syntax description	~	First leading code
	**	Host ok!
	CHK	Check sum
	(cr)	Carriage return
Response	No Response	



*If watchdog is in enable, send the "Host OK!" before watchdog timeout (B) the watchdog will re-count, PWR LED will flashing after watchdog timeout.

6. Modbus/RTU Command Description

The TRP-C68 AIO support Modbus/RTU protocol, The serial communication data format is
Start bit: 1,
Data bit: 8,
Parity check: None,
Stop bit: 1,
Baud-rate: 1200bps~115200bps.

6-1. Modbus Syntax

Command Format :ID(HEX)+FC(HEX)+SU(HEX)+DA(HEX) or RC(HEX)+CRC16(HEX),
Response Format : ID(HEX)+FC(HEX)+SU(HEX)+DA(HEX) or RC(HEX)+CRC16(HEX),
Error Format: ID(HEX)+ FC(HEX)+ CRC16(HEX).

ID: RS485 Device Address (HEX).....1~247 1Byte,
FC: Function Code (HEX)...1 Byte,
SU: Sub Function (HEX).....1 Byte,
DA: Data Format....No Limit,
RC: Reserved code...No Limit,
CRC: Cyclic Redundancy Check...2 Byte.

****Error Response: If CRC IS mismatches error the response is empty!***

7. Modbus/RTU Command List

Command List	Function Description	Index
ID 46 00 00 (CRC)	Read the module's name	7-1
ID 46 04 IP 00 00 00 (CRC)	Set up the module's address	7-2
ID 46 05 00 (CRC)	Read the module's configuration	7-3
ID 46 06 00 BD 00 TT 00 DF 00 00 (CRC)	Set up the module's configuration	7-4
ID 46 07 00 (CRC)	Read the module's Firmware	7-5
ID 46 08 00 (CRC)	Read the reset status	7-6
ID 46 09 00 (CRC)	Set up the module reset	7-7
ID 46 21 HL 00(CRC)	Select analog channel Disable/Enable	7-8
ID 46 22 00 (CRC)	Read all channel Disable/Enable status	7-9
ID 46 25 XX 00 (CRC)	Perform Spam Calibration	7-10
ID 46 26 00 (CRC)	Perform Zero Calibration	7-11
ID 46 27 00 (CRC)	Perform full Calibration	7-12
ID 03 00 NN 00 CN (CRC)	Read one or multi channel analog input data	7-13
ID 04 00 NN 00 CN (CRC)	Read one or multi channel analog input data	7-13

7-1. Read the module's name

Command	ID 46 00 00 (CRC)	
Syntax Description	ID	Address of setting module 01~247
	46	Function code
	00	Read module's name
	00	Reserved code
Response	ID 46 00 00 0C 68 00 (CRC)	ID 46 00 00Module command Line 0C 68 :Module's Name is C68
	ID C6 00 (CRC)	ID C6 (CRC) C6:Error function code 00 : Reserved code

Example:

Send Command: " 01 46 00 00 " .Read the TRP-C68's name,

Response: " 01 46 00 00 0C 68 00 ".....Module's name is C68,

Error Response: "01 C6 00 ".....Error code.

7-2. Set up the module's address

Command	ID 46 04 IP 00 00 00 (CRC)	
Syntax Description	ID	Address of setting module 1~247
	46	Function Code
	04	Set up module's ID
	IP	New module's ID
	00 00 00	Reserved code
Response	ID 46 04 00 00 00 00 (CRC)	ID 46 04 00 00 00 00Command valid.
	ID C6 00 (CRC)	ID C6 (CRC) C6:Error function code 00 : Reserved code

Example:

Send Command: " 01 46 04 02 0 0 0 " .Set up the new ID is "02",

Response: " 01 46 04 00 00 00 00 ".....New ID changes to 02 ,

Error Response: "01 C6 00".....Error code.

7-3. Read the module's configuration

Command	ID 46 05 00 (CRC)	
Syntax Description	ID	Address of setting module 1~247
	46	Function Code
	05	Read module's configuration
	00	Reserved code
Response	ID 46 05 00 BD 00 TT 00 DF 00 00 (CRC)	ID 46 05 00Module command Line BD: Baud-Rate....See 7-3-2 TT: Analog Input type....See 7-3-1 DF: Data format....See 7-3-3
	ID C6 00 (CRC)	ID C6 (CRC) C6:Error function code 00 : Reserved code

7-3-1. (TT) Analog input type

Type Code	08	09	0A	0B	0C	0D
Voltage:	±10V	±5V	±2.5V	±1.25V	±650mV	±20mA
% of FSR	±100 %	±100 %	±100 %	±100 %	±100 %	±100 %
2'S complement	0000~8000~FFFF	0000~8000~FFFF	0000~8000~FFFF	0000~8000~FFFF	0000~8000~FFFF	0000~8000~FFFF
HEX	(HEX)	(HEX)	(HEX)	(HEX)	(HEX)	(HEX)

7-3-2. (BB) Baud Rate Setting

Code number	03	04	05	06	07	08	09	0A
Baud rate	1200	2400	4800	9600	19200	38400	57600	115200

7-3-3. (DD) Data format setting

Bit	7	6	5	4	3	2	1	0
Function	Rejection *0=60Hz 1=50Hz	Checksum *0:Disable 1:Enable	Mode *0=Normal 1=Fast	0	0	0	Engineer Unit Format *00=Voltage 01=Percent 10=2's Complement HEX Format	

Example:

Send Command: " 01 46 05 00 " Read TRP-C68's configuration,

Response:" 01 46 05 00 **06** 00 **08** 00 **08** 00 00 "

Error Response: "01 C6 00 ".....Error code .

7-4. Set up the module's configuration

Command	ID 46 06 00 BD 00 TT 00 DF 00 00 (CRC)	
Syntax Description	ID	Address of setting module 1~247
	46	Function Code
	06	Set up module's configuration
	00 BD 00 TT 00 DF 00 00	BD: Baud-Rate....See 7-3-2 TT: Analog Input type....See 7-3-1 DF: Data format....See 7-3-3
Response	ID 46 06 00 00 00 00 00 00 00 00 (CRC)	ID 46 06 00Module command Line 00 00 00 00 00 00 00 00 : Reserved code
	ID C6 00 (CRC)	ID C6 (CRC) C6:Error function code 00 : Reserved code

Example:

Send Command: " 1 46 06 00 **05** 00 **08** 00 **00** 00 00 " .Set up TRP-C68's configuration,

Response:" 01 46 06 00 00 00 00 00 00 00 " ...Command valid!,

Error Response: "01 C6 ".....Error code,

*Baud-Rate set to 4800

Analog input typ:+/-10V

Data format:00.

7-5. Read the module's Firmware

Command	ID 46 07 00 (CRC)	
Syntax Description	ID	Address of setting module 1~247
	46	Function Code
	07	Read module's Firmware
	00	Reserved code
Response	ID 46 07 YY MM DD 00(CRC)	ID 46 20Module command Line YY:Year, MM :Month ,DD:Date , 00 : Reserved code
	ID C6 00 (CRC)	ID C6 (CRC) C6:Error function code 00 : Reserved code

Example:

Send Command: " 01 46 07 00 " .Set up TRP-C68's configuration,
 Response:" 01 46 07 07 04 07 00"...2007 /04/07 12.2006 TRP-C68 Firmware Version,
 Error Response: "01 C6 00 ".....Error code.

7-6.Read the reset status

Command	ID 46 08 00 (CRC)	
Syntax Description	ID	Address of setting module 01~247
	46	Function code
	08	Read reset status
	00	Reserved code
Response	ID 46 08 XX 00 (CRC)	ID 46 08 00Module command Line XX=01 Have been reset , 00:Have been read
	ID C6 00 (CRC)	ID C6 (CRC) C6:Error function code 00 : Reserved code

Example:

Send Command: " 01 46 08 00 " .Read the TRP-C68's reset status,
 Response: " 01 46 08 01 00 ".....Have been reset,
 Error Response: "01 C6 00 ".....Error code.

7-7. Set up the module reset

Command	ID 46 09 00 (CRC)	
Syntax Description	ID	Address of setting module 1~247
	46	Function Code
	09	Module Reset
	00	Reserved code
Response	ID 46 09 00 (CRC)	Module reset
	ID C6 00 (CRC)	ID C6 (CRC) C6:Function Code 00: Reserved code

Example:

Send Command: " 01 46 09 00",

Response:"01 46 09 00...Command valid,

Error Response: "01 C6 00"...Error code.

7-8. Select analog channel Disable/Enable

Command	ID 46 21 HL 00 (CRC)	
Syntax Description	ID	Address of setting module 1~247
	46	Function Code
	21	Read module's Firmware
	HL	H: Channel 4~7 L: Channel 0~3 0:Channel disable 1:Channel Enable
	00	Reserved code
Response	ID 46 21 NN 00(CRC)	Command valid
	ID C6 00 (CRC)	ID C6 (CRC) C6:Error function code 00 : Reserved code

Example:

Send Command: " 01 46 21 0F 00 "Enable Channel 0~3, Disable Channel 4~7,

Response:" 01 46 21 0F 00 "...Command Valid,

Error Response: "01 C6 00 "Error code.

7-9. Read all channel Disable/Enable status

Command	ID 46 22 00 (CRC)	
Syntax Description	ID	Address of setting module 1~247
	46	Function Code
	22	Read all channel disable/enable status
	00	Reserved code
Response	ID 46 22 HL 00 (CRC)	ID 46 22Module command Line HL=Channel 0~F enable/disable status 00 : Reserved code
	ID C6 00 (CRC)	ID C6 (CRC) C6:Error function code 00 : Reserved code

Example:

Send command : " 01 46 22 00".....Data Channel,

Response:" 01 46 22 0F 00"...Channel 0~3 is enable, Channel 4~7 is disable,

Error Response: "01 C6 00 ".....Error code.

7-10. Perform Spam Calibration

Command	ID 46 25 XX 00 (CRC)	
Syntax Description	ID	Address of setting module 1~247
	46	Function Code
	25	Spam calibration enable
	XX	XX=00 Disable XX=01 Enable
	00	Reserved code
Response	ID 46 25 00 00 (CRC)	ID 46 25 00Module command Line 00 : Reserved code
	ID C6 00 (CRC)	ID C6 (CRC) C6:Error function code 00 : Reserved code

Example:

Send command "01 46 25 01 00",

Response:" 01 46 25 00"...Set up enable,

Error Response: "01 C6 00".....Error code.

***Refer to paragraph 4 Function description before calibration.**

7-11. Perform Zero Calibration

Command	ID 46 26 00 (CRC)	
Syntax Description	ID	Address of setting module 1~247
	46	Function Code
	26	Spam zero calibration
	00	Reserved code
Response	ID 46 26 00 (CRC)	ID 46 26Module command Line 00 : Reserved code
	ID C6 00 (CRC)	ID C6 (CRC) C6:Error function code 00 : Reserved code

Example:

Send command :”01 46 26 00”,

Response:” 01 46 26 00”....Command valid,

Error Response: “01 C6 00 ”.....Error code.

****Refer to paragraph 4 Function description before calibration.***

7-12. Perform full Calibration

Command	ID 46 27 00 (CRC)	
Syntax Description	ID	Address of setting module 1~247
	46	Function Code
	27	Spam full calibration
	00	Reserved code
Response	ID 46 27 00 (CRC)	ID 46 27Module command Line 00 : Reserved code
	ID C6 00 (CRC)	ID C6 (CRC) C6:Error function code 00 : Reserved code

Example:

Send command :”01 46 27 00”,

Response:” 01 46 27 00”....Command valid,

Error Response: “01 C6”.....Error code.

****Refer to paragraph 4 Function description before calibration.***

7-13. Read one or multi channel analog input data

Command	ID 03 00 NN 00 CN (CRC) ID 04 00 NN 00 CN (CRC)	
Syntax Description	ID	Address of setting module 1~247
	03 or 04	Function Code
	00 NN	Start channel from NN=00~07
	00 CN	How many channel want to read CN=1~8
Response	ID 03/04 BC ST DATA (CRC)	ID 03 or 04Module command Line BC: Byte Counter ST:01...when Voltage or % of FSR is Positive ST:00.... when Voltage or % of FSR is Negative ST:02.....when fast mode and engineer mode is 2byte ST:03.....when normal mode and engineer mode is 3byte DATA: Analog Input value
	ID 83 ER (CRC)	ID 83 :Function Code ER=00 Syntax error ER=01 Data Format error ER=02 Start channel error ER=03 I/O out of range

Example:

TT=08, DF:00

Send command "1 3 0 0 0 1"...Read channel 0 voltage

Response:" 01 03 05 **10** 00 87 89 65 ".....+8.78965V.

**When voltage or % of FSR mode the data length is 5 byte, 1st byte is 10: Positive,00: Negative*

Example:

When DF is 02 (Engineer and normal mode) ,Byte Counter is 3 bytes .

TT=08, DF:02 DF: fast mode display 3 byte,

Send command "01 03 00 00 01 "...Read channel 0 engineer mode :0000~8000~FFF /HEX=-10V~0V~+10V

Response:" 01 03 03 **B7 BD DB** "...10: Engineer mode AC 1A =about +4.3V

When DF is 22 (Engineer And fast Mode)..Byte Counter Is 2 Bytes

TT=08, DF:22 DF: fast mode display 2 byte,

Send command "01 03 00 00 01 "...Read channel 0 engineer mode :0000~8000~FFF /HEX=-10V~0V~+10V

Response:" 01 03 02 **AC 1A** "...10: Engineer mode AC 1A =about +3.3V

Example:

TT=08, DF:02 DF: normal mode display 3 byte, Engineer Mode

Send command "01 03 00 00 01 "...Read channel 0 engineer mode :000000~800000~FFFFF

/HEX=

-10V~0V~+10V

Response:" 01 03 03 **EE 1C BD** "...10: Engineer mode EE 1C BD =about +8.58V

Example:

TT=09, DF:01

Send command "01 46 06 00 **06 00 09 00 01 00 00**"....BD=9600,TT=09=+/-5V,DF=01
=% of FSR.....set up configuration ...see 7.4

Response:" 01 46 06 00 00 00 00 00 00 00 00"

Send command "01 03 00 00 01 "...Read channel 0 % of FSR

Response:" 01 03 05 10 00 **51 43 59** "...51 43 59= + 51.4359 %.....about +2.55V

Example:

Send command : "01 03 00 00 00 08".....Read all channel,

Response:" 01 03 28 **00 00 02 27 97** 00 00 00 00 61 **10 00 00 01 22** 00 00 00 00 61 **10 00 00 00 00 10 00 00 00 00 10 00 00 00 00 10 00 00 00 00** " **Voltage/ Unit . Data format=00**

Note: Some Modbus utility support 2 byte data each channel like Modbus Poll , but the TRP-C68 standard mode is support 5 byte for display , If user use the that utility ,the TRP-C68 must be adjust the data format .

Example :

Send command: "02 46 06 00 **06 00 08 00 02 00 00**"....Set the BD=06=9600, TT=08=+/-10V, DF=02=Engineer display.

Response: "02 46 06 00 00 00 00 00 00 00 00".....Command valid.

Then send the command : "1 3 0 0 0 1".....Read channel 0 voltage

Response:" 02 03 02 **E1 C1**"Channel 0 data is ="**E1 C1**"

Note: The engineer's display is 0000(hex)~8000(hex)~FFFF(hex)=-10V~0V~+10V

Example:

TT=09, DF:01

Send command "01 46 06 00 **06 00 09 00 01 00 00**"....BD=9600,TT=09=+/-5V,DF=01
=% of FSR.....set up configuration ...see 7.4

Response:" 01 46 06 00 00 00 00 00 00 00 00"

Send command "01 03 00 00 01 "...Read channel 0 % of FSR

Response:" 01 03 05 10 00 **51 43 59** "...51 43 59= + 51.4359 %.....about +2.55V

Example:

TT=08, DF=00

Send command "01 03 00 05 0 3 "...Read channel 5~7

Response:" 01 03 0F 10 00 79 88 53 10 00 00 14 35 10 00 19 37 00 "...Channel 5=+7.98853V, Channel 6=+0V, Channel 7=+1.937V

7. How to use the utility for windows

The TRPCOM utility can help you to test and configuration the module's data transmit and receive analog input data and output communication status. User may download TRPCOM software from TRYCOM web www.trycom.com.tw.

1.The "Setting " function is for user to initiate the software to set the Com Port from 1 to 20 and setting the Baud-Rate from 1200 to 115200,Checksum Enable or Disable. See Figure 1

*The Module Factory Setting is "9600" and "ID" is 01, Checksum is Disable.

*Turn module's switch to "OFF,ON" position into ASCII communication mode.

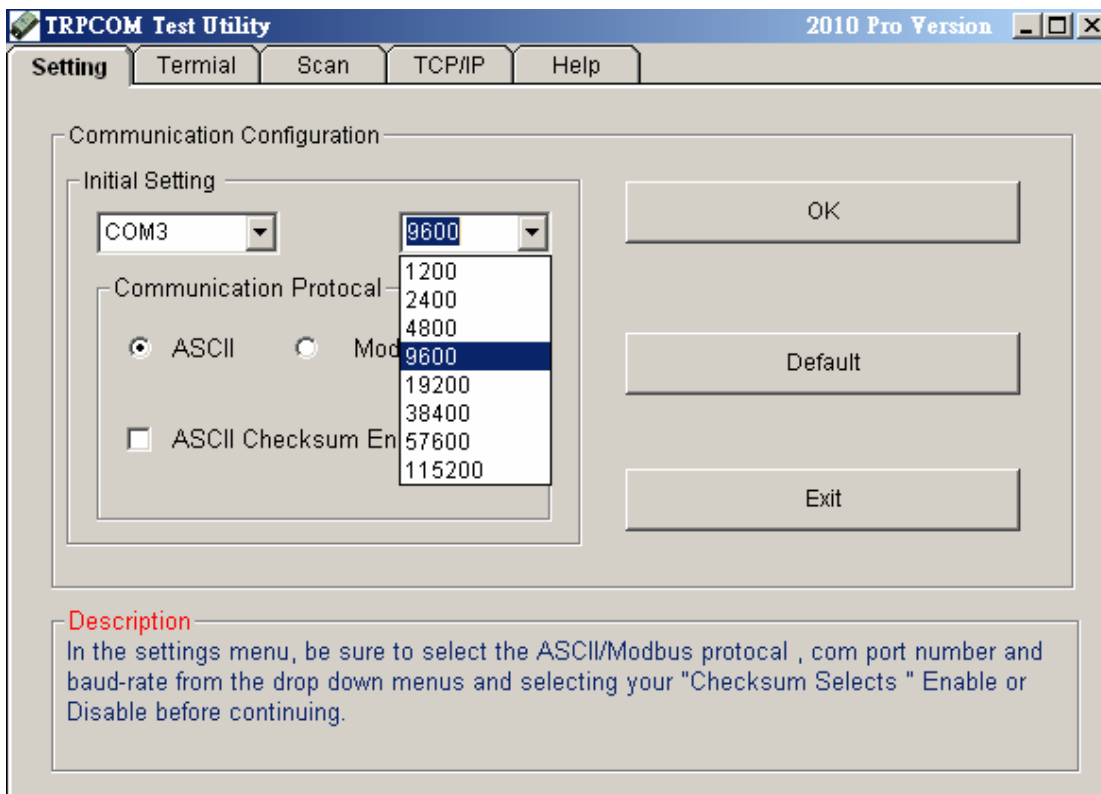

Figure 1

2.The "Terminal" function is for user to input command, user can control all of module's digital input/output status or wait to get module response status See Figure 2.

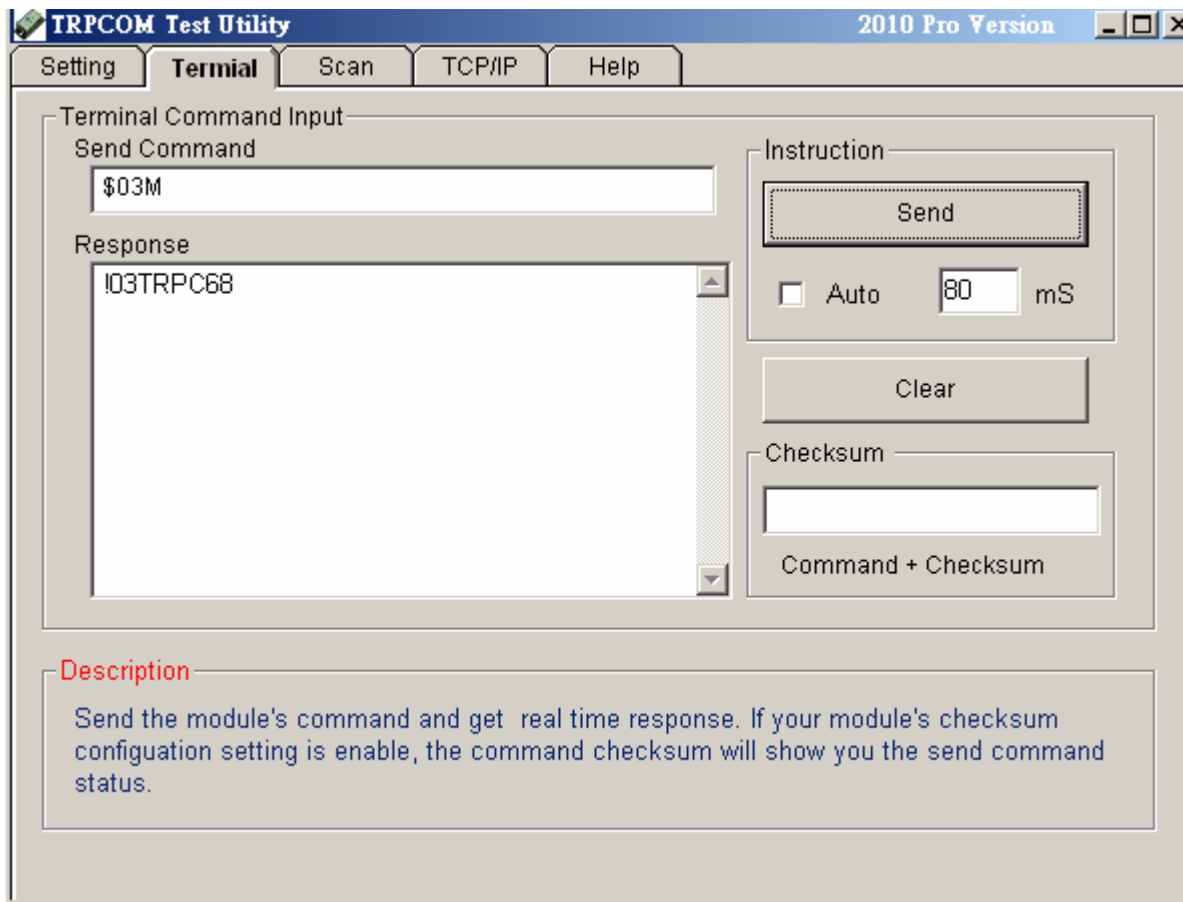
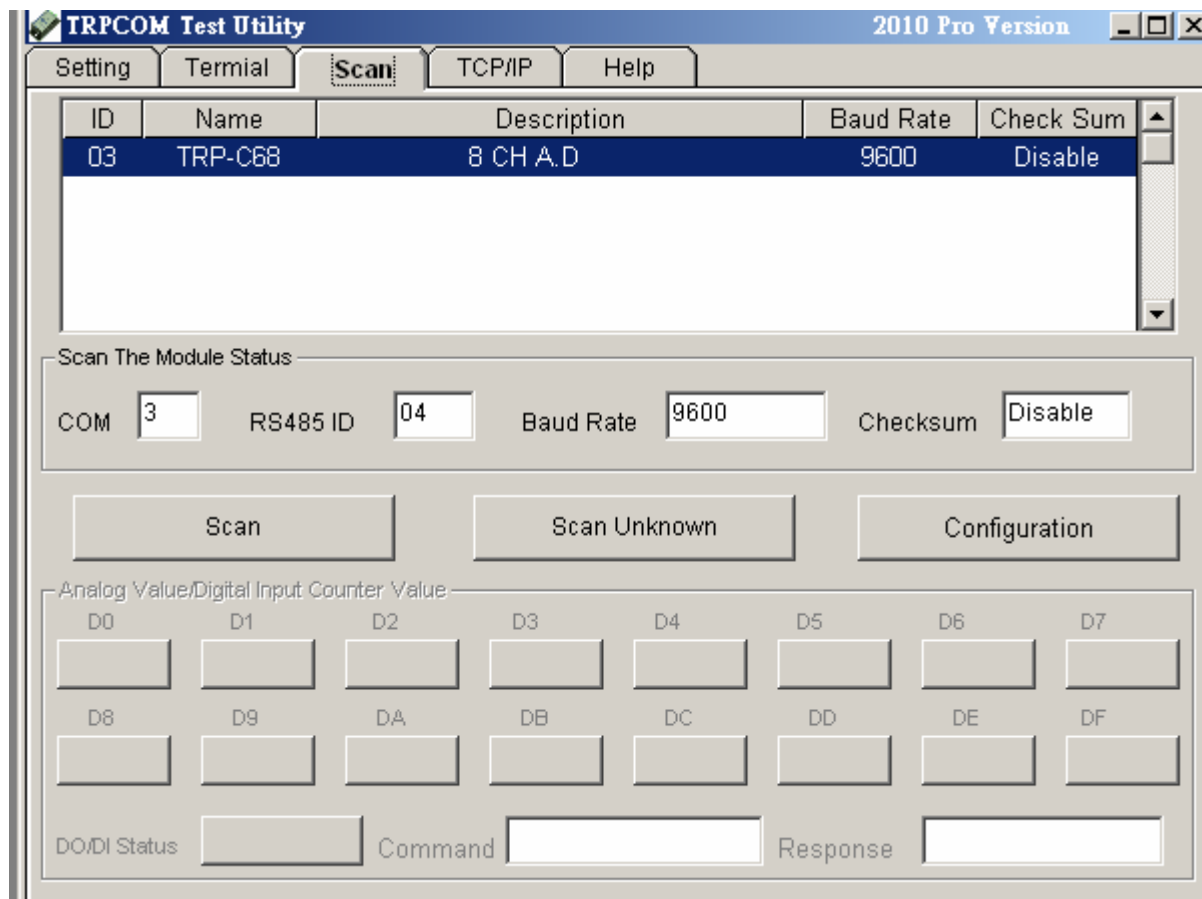

Figure 2

If you don't know the module's ID may select "Scan" to find the module's setting.



Select the module which one you want setting then click “Configuration”.

Example: TRP-C68 Configuration

A: Get analog input voltage Value please click “D0~D7” button.

B: Set up new RS485 ID, Baud-Rate and data format then click “Write to EEPROM” button.

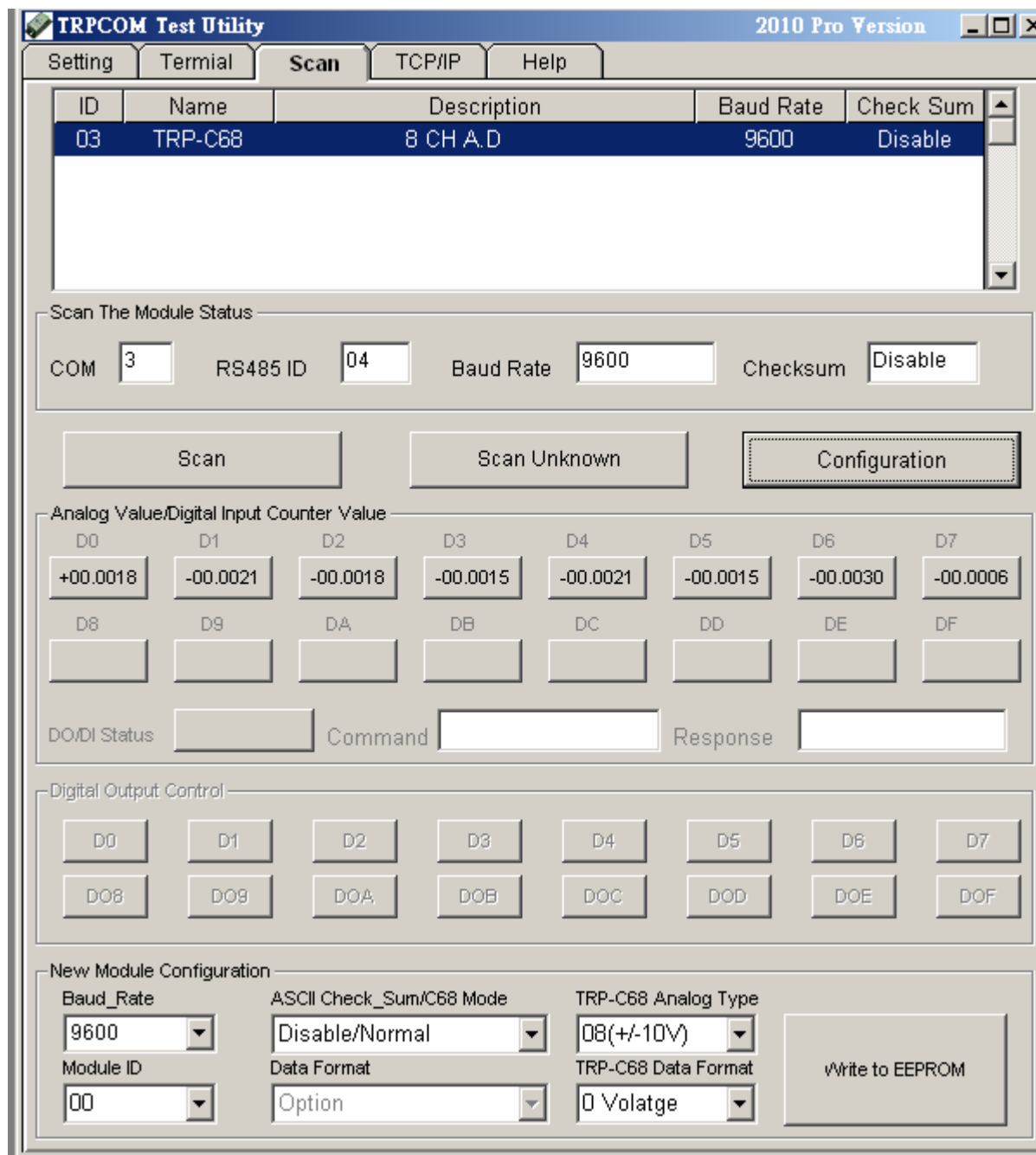

8.Application



9. Using the Modbus poll for test the TRP-DIO and AIO

The **Modbus poll** is the very popular utility that supports the Modbus RTU/ASCII and Modbus TCP/IP, you can download that for test the any TRP-DIO and AIO basic Modbus function.

The download website is http://www.modbustools.com/modbus_poll.asp