

Aranet PRO

Quick Start

Guide



1. CHECK THE CONTENTS OF THE BOX

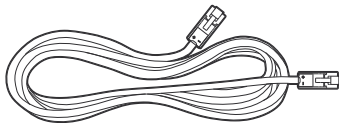
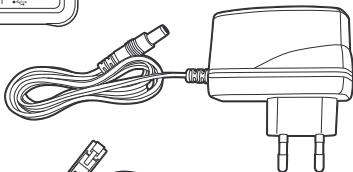
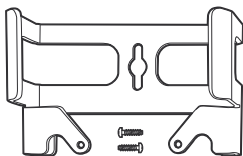
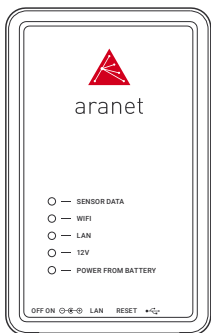

2. ATTACH THE DEVICE TO THE MOUNT

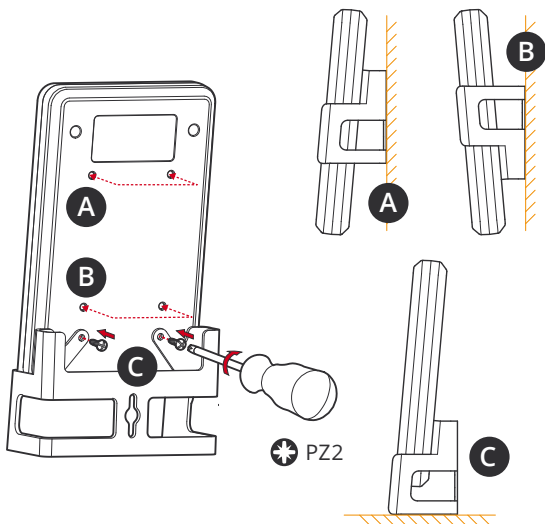

3. CONNECT POWER TO THE DEVICE

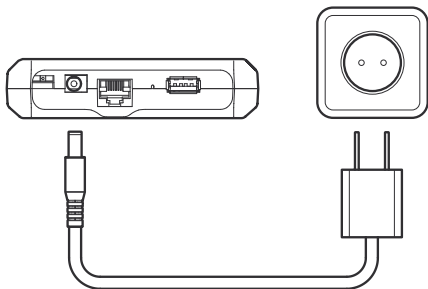

4. TURN THE DEVICE ON

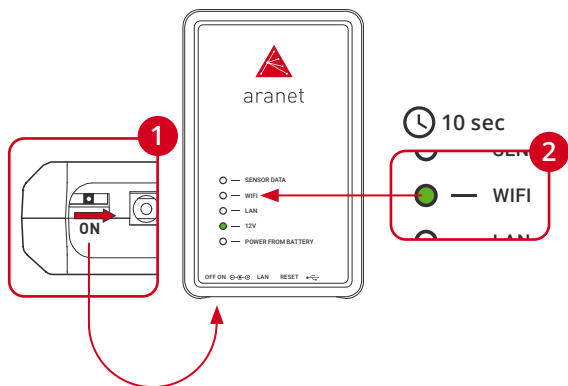

5. CONNECT TO THE DEVICE

WiFi SSID "Aranet-*****"

<http://192.168.206.100>

Login

Username
root

Password

Remember me LOGIN

THE DEFAULT
ADMINISTRATOR
LOGIN

Username: **root**

Password: **changeme**

6. CONFIGURE THE DEVICE



Change your password, modify and add users in the **Users** setting section.



Set the device time in the **System > Time** setting section.



Scan the availability of the radio channel in the **Sensors > Radio** setting section.



Pair your sensors by pressing the **Add sensor** button in the **Sensors > Sensors** setting section.



Enter the **Notifications** setting section, to configure your sms and/or e-mail notifications.

ADDITIONAL RESOURCES

Please refer to the Aranet PRO User Manual for detailed instructions

<https://aranet.com/product/aranet-pro/user-manual/>

To view Terms&Conditions visit

<https://aranet.com/terms-and-conditions/>

To view Returns&Guarantees visit

<https://aranet.com/returns-guarantees/>

To fill RMA form visit

<https://aranet.com/rma/>

DEUTSCHE



- 1 Überprüfen Sie den Lieferumfang
 - 2 Montieren Sie das Gerät an der Halterung
 - 3 Verbinden Sie das Gerät mit der Spannungsversorgung / Optionales Zubehör PoE
 - 4 Schalten Sie das Gerät ein
 - 5 Stellen Sie eine Verbindung mit dem Gerät her
 - 6 Konfigurieren Sie das Gerät
- 👤 **Ändern des Passworts** und Ändern oder Hinzufügen von Benutzer in den **Benutzer**.
 - 🕒 Einstellen der Gerätezeit in **System > Zeit**.
 - 📶 Prüfen Sie die Kanalverfügbarkeit in **Sensoren > Radio**.
 - ⊕ Um Sensoren anzubinden, drücken Sie die **Sensor hinzufügen** in **Sensoren > Sensoren**.
 - ✉️ SMS - und / oder E-Mail-Benachrichtigungen verwalten in den **Benachrichtigung**.

Um das Aranet PRO Benutzerhandbuch einzusehen, besuchen Sie <https://aranet.com/product/aranet-pro/user-manual/>

ESPAÑOL



- 1 Verifique el contenido de la caja
 - 2 Adjunte el dispositivo al soporte
 - 3 Conecte el dispositivo a la energía / Accesorio opcional PoE
 - 4 Encienda el dispositivo
 - 5 Conéctese al dispositivo
 - 6 Configura el dispositivo
- 👤 **Cambie su contraseña**, modifique y agregue usuarios en la sección **Configuración de Usuarios**
 - 🕒 Configure la hora del dispositivo en la sección Configuración del **Sistema > Tiempo**
 - 📶 Escanee la disponibilidad del canal de radio en la sección **Sensores > Configuración de Radio**
 - ⊕ Empareje sus sensores presionando el botón **Añadir sensor** en la sección de configuración **Sensores > Sensores**
 - ✉️ Ingrese a la sección Configuración de **Notificaciones** para configurar sus sms y / o notificaciones por correo electrónico.

Para ver la Guía del usuario de Aranet PRO, visite <https://aranet.com/product/aranet-pro/user-manual/>

FRANÇAIS



- 1 Vérifiez le contenu de la box
 - 2 Attacher l'appareil à la monture
 - 3 Connectez l'alimentation à l'appareil / Accessoire optionnel de PoE
 - 4 Allumez l'appareil
 - 5 Connectez à l'appareil
 - 6 Configurer l'appareil
- 👤 **Changez votre mot de passe**, modifiez et ajoutez des utilisateurs dans la section **Utilisateurs**.
 - 🕒 Définissez l'heure de l'appareil dans la section **Système > Temps**.
 - 📶 Parcourez la disponibilité du canal radio dans la section **Capteurs > Radio**
 - ⊕ Associez vos capteurs en appuyant sur le bouton **Ajouter un capteur** dans la section **Capteurs > Capteurs**.
 - ✉ Entrez dans la section **Notifications** pour configurer vos notifications par SMS et / ou e-mail.

Pour voir le guide de l'utilisateur Aranet PRO, veuillez visiter <https://aranet.com/product/aranet-pro/user-manual/>

ITALIANO



- 1 Verificare il contenuto della scatola
 - 2 Attaccare il dispositivo al supporto
 - 3 Collegare il dispositivo all'alimentazione / Accessorio opzionale PoE
 - 4 Accendere il dispositivo
 - 5 Connettersi al dispositivo
 - 6 Configurare il dispositivo
- 👤 **Cambiare la password**, modificare e aggiungere utenti nella sezione Impostazioni **Utenti**.
 - 🕒 Impostare l'orario nella sezione **Sistema > Impostazione Ora**.
 - 📶 Scansionare la disponibilità di canali radio nella sezione **Sensori > Impostazioni Radio**.
 - ⊕ Allineare i sensori premendo il pulsante **Aggiungi Sensore** nella sezione **Sensori > Impostazioni Sensori**.
 - ✉ Accedere alla sezione Impostazioni **Notifiche** per configurare SMS e/o notifiche via email.

Per consultare la Guida d'Utente Aranet PRO visitare <https://aranet.com/product/aranet-pro/user-manual/>

LATVIEŠU



- 1 Pārbaudiet iepakojuma saturu
 - 2 Pieskrūvējiet stiprinājumu pie ierīces
 - 3 Pievienojiet ierīci pie elektrobarošanas / Papildus PoE aksesuārs
 - 4 Ieslēdziet ierīci
 - 5 Pieslēdzieties ierīcei
 - 6 Iestatiet ierīci
- 👤 **Nomainiet paroli**, modificējiet un pievienojiet lietotājus **Lietotāji** sadaļā.
 - 🕒 Iestatiet laiku un datumu **Sistēma > Laiks** sadaļā.
 - 📶 Pārbaudiet radio kanālu pieejamību **Devēji > Radio** sadaļā.
 - ⊕ **Pievienojiet devējus**, nospiežot **Pievienot devēju** pogu **Devēji > Devēji** sadaļā.
 - ✉️ Apmeklējiet sadaļu **Paziņojumi**, lai mainītu SMS un e-pastu paziņojumu iestatījumus.

Lai skatītu pilnu Aranet PRO rokasgrāmatu, apmeklējiet <https://aranet.com/product/aranet-pro/user-manual/>

NEDERLANDS



- 1 Controleer inhoud van de doos
 - 2 Bevestig de standaard aan het apparaat
 - 3 Sluit de stroombron aan / PoE optionele accessoire
 - 4 Zet het apparaat aan
 - 5 Verbind aan het apparaat
 - 6 Configureer het apparaat
- 👤 **Verander password**, voeg **Gebruikers** toe in Instellingen.
 - 🕒 Stel tijd in **Systeem > Tijd**.
 - 📶 Scan beschikbaarheid radiokanalen in **Sensoren > Radio**.
 - ⊕ **Verbind sensor** met apparaat door te drukken op **Voeg sensor toe** in Sensoren > **Sensoren** instellingen.
 - ✉️ Kies **Meldingen** om SMS en/of e-mail notificaties in te stellen.

Om Aranet PRO handleiding te bekijken bezoek <https://aranet.com/product/aranet-pro/user-manual/>

NORSK



- 1 Sjekk boksens innhold
 - 2 Fest enheten til festeanordningen
 - 3 Kobl strøm til enheten / Valgfritt tilbehør til PoE
 - 4 Slå enheten på
 - 5 Tilkobl enheten
 - 6 Konfigurer enheten
- 👤 **Endr passordet**, konfigurere og legg til brukere i avdeling **Users**.
 - 🕒 Angi enhetens tid i avdeling av innstillinger **System > Time**.
 - 📶 Utfør skanning av tilgjengelige radiokanaler i avdeling av innstillinger **Sensor > Radio**.
 - ⊕ Utfør paring av dine sensorer ved å trykke på knappen **Add sensor** i avdeling av innstillinger **Sensors > Sensors**.
 - ✉ Gå inn i avdeling av innstillinger **Notifications** for å konfigurere dine sms og/eller e-post varslinger.

For å se på brukerveiledning til "Aranet PRO", vennligst besøk <https://aranet.com/product/aranet-pro/user-manual/>

PORTUGUESES



- 1 Verifique o conteúdo da caixa
 - 2 Anexar o dispositivo ao suporte
 - 3 Conecte o dispositivo à energia elétrica / Acessório opcional PoE
 - 4 Ligue o aparelho
 - 5 Conecte-se ao dispositivo
 - 6 Configurar o dispositivo
- 👤 **Utilizadores**, modifique e adicione usuários na seção Configuração do **usuário**.
 - 🕒 Defina a hora do dispositivo na seção **Sistema > Hora**.
 - 📶 Analise a disponibilidade do canal de rádio na seção **Sensores > Rádio**.
 - ⊕ Emparelhe seus sensores pressionando o botão **Adicionar sensor** na seção de configuração **Sensores > Sensores**.
 - ✉ Entre na seção de configuração de **Notificações** para configurar suas notificações por SMS e / ou e-mail.

Para ver o Guia do Usuário do Aranet PRO, visite <https://aranet.com/product/aranet-pro/user-manual/>

РУССКИЙ



- 1 Проверьте содержимое коробки
 - 2 Присоедините устройство к креплению
 - 3 Подключите питание к устройству / Дополнительный PoE аксессуар
 - 4 Включите устройство
 - 5 Подключитесь к устройству
 - 6 Произведите настройку устройства
- 👤 **Измените свой пароль**, измените и добавьте пользователей в разделе **Пользователи**.
 - 🕒 Установите время устройства в **Система** > раздел **Время**.
 - 📶 Просканируйте доступность радиоканалов в **Датчики** > раздел **Радио**.
 - ⊕ Присоедините свои датчики, нажимая кнопку **Добавить датчик в Датчики** > раздел **Датчики**.
 - ✉ В разделе **Уведомления** настройте свои уведомления по СМС и/или электронной почте.

Для просмотра руководства пользователя Aranet PRO посетите <https://aranet.com/product/aranet-pro/user-manual/>

SUOMALAINEN



- 1 Tarkista laatikon sisältö
 - 2 Liitä laite kiinnikkeeseen
 - 3 Kytke virta laitteeseen / PoE valinnainen lisävaruste
 - 4 Kytke laite päälle
 - 5 Yhdistä laitteeseen
 - 6 Määritä laitteen asetukset
- 👤 **Vaihda salasanasi**, muuta ja lisää käyttäjät **Users** asetusten osiossa.
 - 🕒 Aseta laitteen aikaa **System** > **Time** asetusten osiossa.
 - 📶 Tarkista radiokanavien saatavuus **Sensors** > **Radio** asetusten osiossa.
 - ⊕ Muodosta laitepari painamalla **Add sensor**-painiketta **Sensors** > **Sensors** asetusten osiossa.
 - ✉ Määritä sms ja/tai sähköposti-ilmoitukset **Notifications** asetusten osiossa.

Nähdäksesi Aranet PRO Käyttöohjee ole hyvä ja käy sivulla <https://aranet.com/product/aranet-pro/user-manual/>

SVENSKA



- 1 Kontrollera innehållet i boxen
 - 2 Fäst enheten på fästet
 - 3 Anslut ström till enheten / Tillvalstillbehör för PoE
 - 4 Slå på enheten
 - 5 Anslut enheten
 - 6 Konfigurera enheten
- 👤 **Ändra ditt lösenord**, konfigurera och lägg till användare i inställningssektion **Users**.
 - 🕒 Ställ in enhetstid i inställningssektion **System > Time**.
 - 📶 Utför skanning av tillgängliga radiokanaler i inställningssektion **Sensors > Radio**.
 - ⊕ Utför parning av dina sensorer genom att trycka på knappen **Add Sensor** i inställningssektion **Sensors > Sensors**.
 - ✉ Gå in i inställningssektion **Notifications** för att konfigurera dina SMS och/eller e-post anmälningar.

För att läsa Användarmanual av "Aranet PRO", besök vänligen <https://aranet.com/product/aranet-pro/user-manual/>

TÜRK



- 1 Kutunun içindekileri kontrol edin
 - 2 Cihazı dayanağına monte edin
 - 3 Cihaza güç kaynağını bağlayın / PoE opsiyonel aksesuar
 - 4 Cihazı açın
 - 5 Cihaza bağlayın
 - 6 Cihazı konfigüre edin
- 👤 **Parolanızı değiştirin, Kullanıcılar** ayarları bölümünde kullanıcı ekleyin veya modifiye edin.
 - 🕒 **Sistem** cihaz zaman ayarını set edin > **Zaman** ayarı bölümü.
 - 📶 **Sensörler** radyo kanalının kullanılabilirliğini tara > **Radyo** ayarları bölümü.
 - ⊕ **Sensörler Sensör Ekle** düğmesine basarak sensörlerinizi eşleştirin > **Sensörler** ayarları bölümü.
 - ✉ Sms ve / veya e-posta bildirimlerinizi yapılandırmak için **Bildirimler** ayar bölümüne girin.

Aranet PRO kullanım kılavuzunu görmek için lütfen ziyaret edin <https://aranet.com/product/aranet-pro/user-manual/>

SCAN QR CODE TO SEE THE ARANET PRO USER MANUAL



The information presented in this guide is the property of SAF Tehnika, JSC. No part of this document may be reproduced or transmitted without proper permission from SAF Tehnika, JSC.

The specifications or information contained in this document are subject to change without notice due to continuing introduction of design improvements. If there is any conflict between this document and compliance statements, the latter will supersede this document.

SAF Tehnika, JSC has no liability for typing errors in this document or damages of any kind that result from the use of this document.

To get up to date information about accessories and their availability, please contact sales representative.

Copyright © 2021 SAF Tehnika, JSC. All rights reserved.